

Data Sheet



Article number: 021816011229

Description: Clamp with bracket and rubber
SPGU 6011. 229/30 SK

Measures

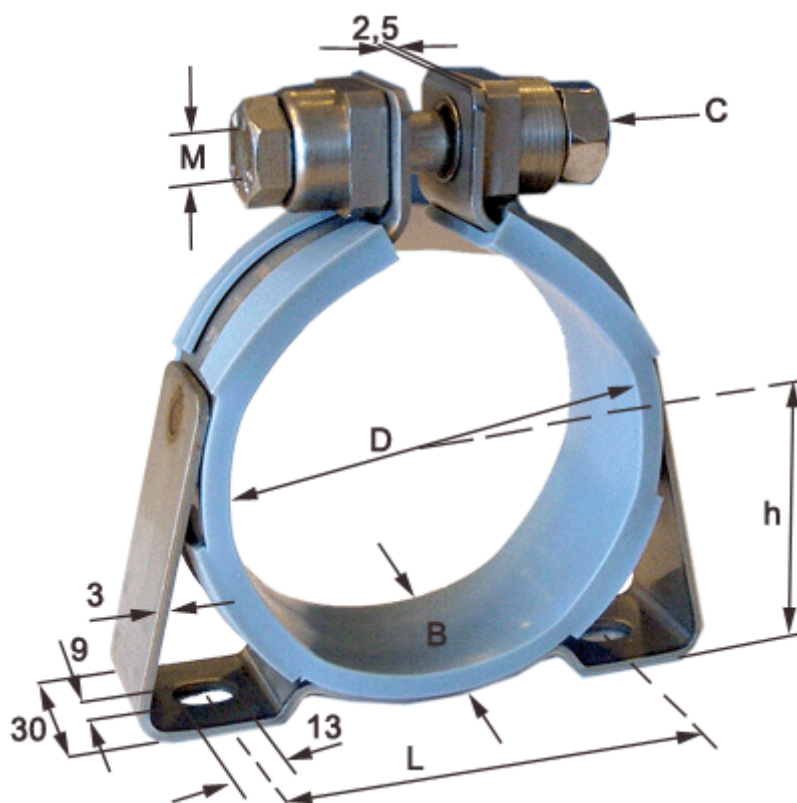

C (screw type) = SK hexagon screw

Diameter D = 229

h = 122

L = 216

Width B = 30